

REQUIRED TOOLS FOR INSTALLATION

OPEN ROLL, MODELS Z-125 | Z-150 | Z-175

Tape Measure

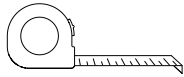

Level

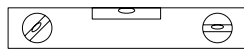

Power Drill / Screwdriver

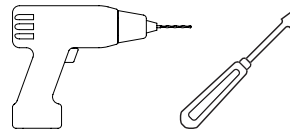

Pencil

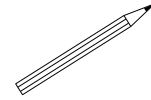

COMES WITH YOUR KIT

Valance

If Ordered

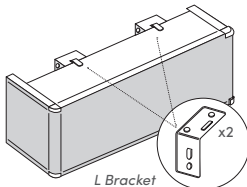

*Note: Returns are optional

Shade Brackets

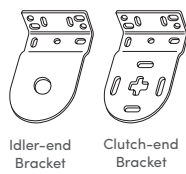

Screws



Roller Shade

Motor | WandControl™ | SpringDrive™

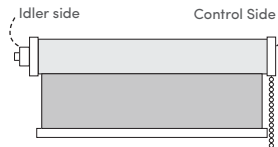

End Caps

If Ordered

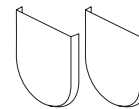

Ball Stoppers

For Chains Only



ROLLER SHADE INSTRUCTIONS

STEP 1 - VALANCE INSTALLATION (If Ordered)

NOTES

- Valance must be installed as a first step before the Roller Shade. If you didn't order a Valance proceed to Step 2.

A - For INSIDE mount divide valance width into thirds mark 2 screw holes on the underside of the valance. Drill through cover to secure the valance in place.

B - For OUTSIDE Valance, mark the location of the shade mounting brackets with a pencil (see step 2), and measure 1/2" from the top of the bracket to note the location of the Valance L bracket. L brackets should be installed 5"-8" from each end of the valance. Additional bracket(s) may be necessary and should be evenly spaced between the two ends brackets if required.

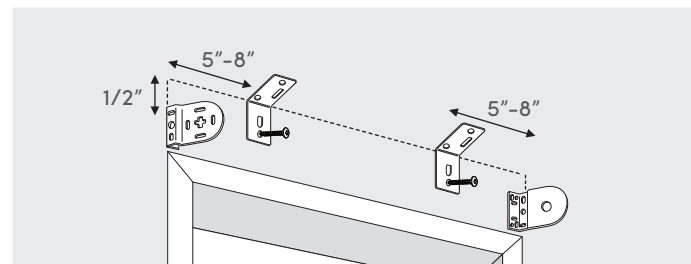
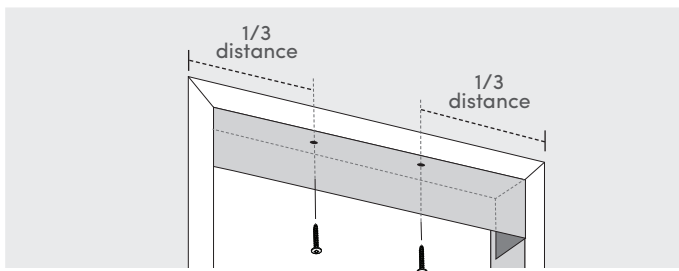

STEP 2 - ROLLER SHADE INSTALLATION

NOTES

- Before fully installing your brackets, note the difference between the clutch and idler brackets.
- In order to ensure the shade does not fall out of the brackets, it is critical that the idler pin is **securely compressed by at least 1/4"** upon installation. If pin is too loose, shade may fall out of brackets. If pin is compressed too tightly, shade may not operate properly.
- End caps are not required when installing a valance.

Idler pin must compress at least 1/4" to ensure shade is properly secured in the brackets.

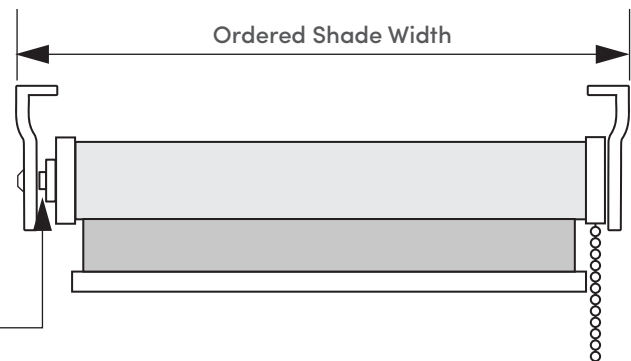

BRACKET INSTALLATION

Mounting Brackets consist of an idler end and a clutch end bracket. Brackets can be positioned for inside mount or outside mount installations. Install the brackets according to L or R side controls.

A Outside Position

B Inside Position

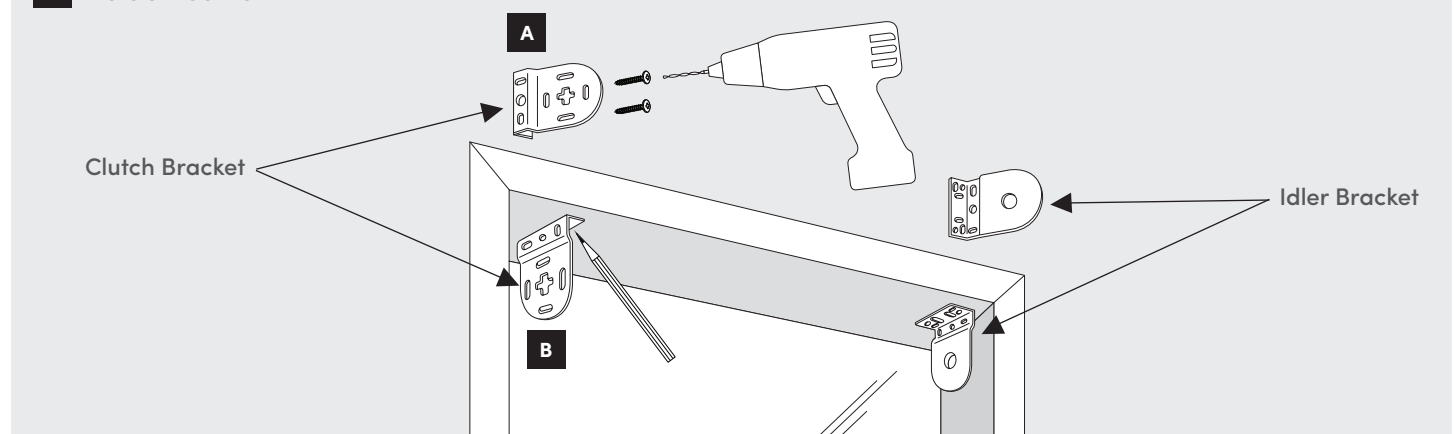

Inside / Outside Mount: Using a steel measuring tape, measure the distance from the outside edge of each bracket according to the ordered shade width. Mark the screw location on the mounting surface with a pencil, snap end caps onto brackets (if ordered).

Fasten brackets according to Left or Right side controls in the marked locations using the screws provided. Ensure brackets are secure, leveled, parallel and facing towards each other.

STEP 3 - SHADE INSTALLATION / HANGING THE SHADE

- NOTES**
- Ensure fabric rolls in the direction you specified (regular or reverse roll)
 - Your control side depends on what you specified

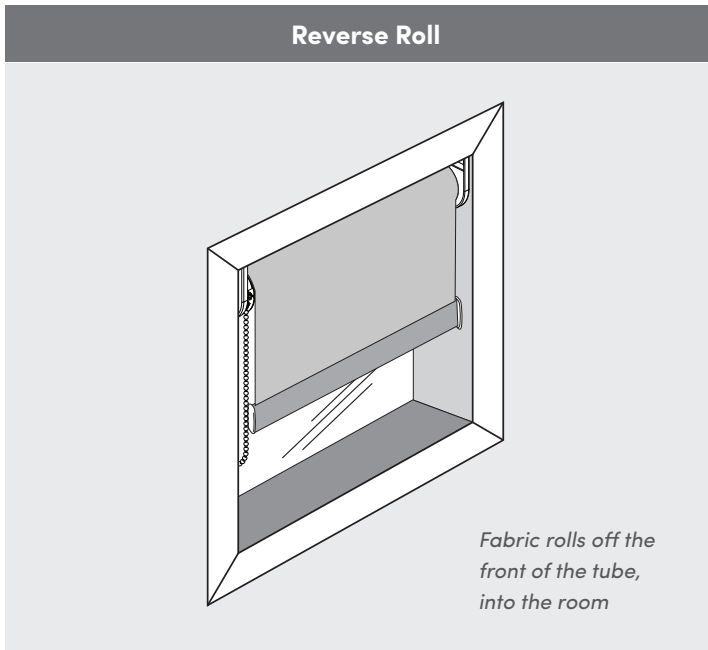
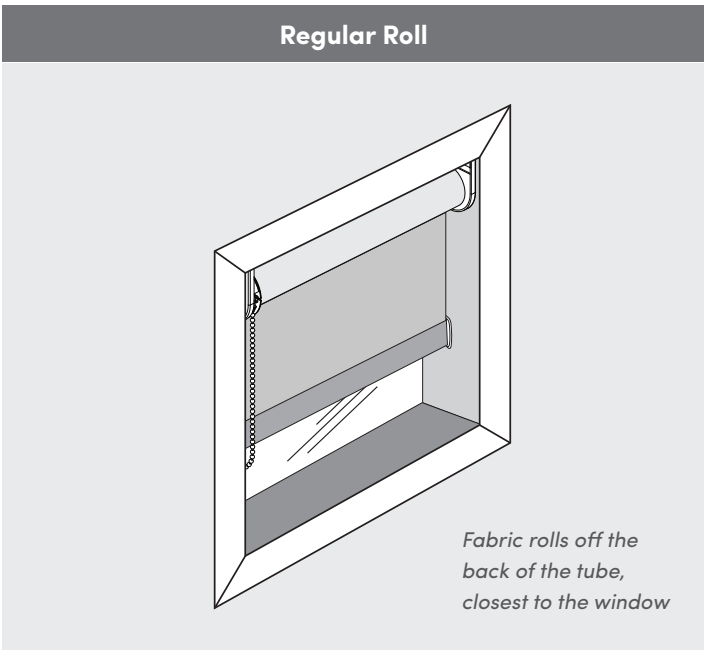

- NOTES**
- Proper installation requires the idler pin to be permanently compressed by at least 1/4" once mounted in the brackets.
 - If necessary, the brackets may need to be installed closer together for a secure fit and to prevent shade from falling out of the brackets.

A - The idler end has spring-loaded pin that allows it to compress in /out. Insert the idler-end into the idler-end bracket, compress and hook the clutch side into the "+" shape of the clutch bracket.

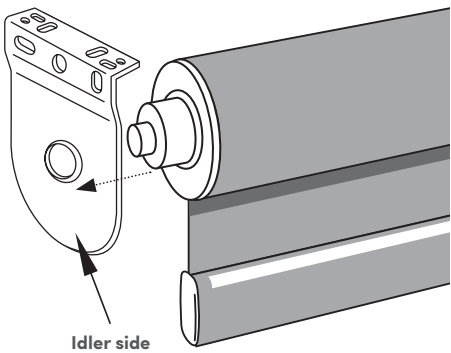

B - Ensure hook on the clutch side is pointing downward and securely fastens into the "+" shaped opening of the clutch bracket.

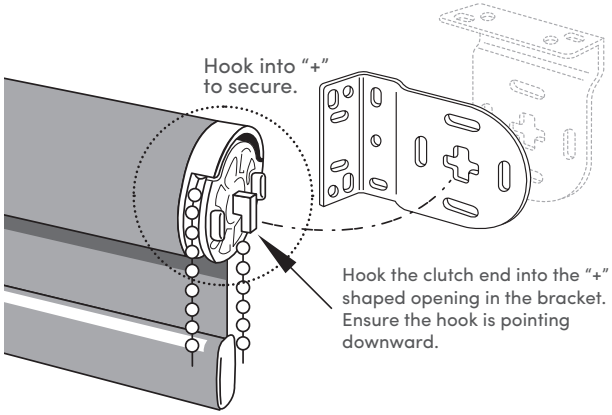

STEP 4 - APPLIES TO CHAIN OPERATION ONLY

CHILD/SAFETY CHAIN TENSIONER INSTALLATION

This device **MUST** be properly installed in accordance with Health Canada regulations on corded window covering products. Fasten cord p-clip against the window frame or wall. Position the p-clip so it does not interfere with the travel of the shade. Cord should be tight, but not under stress when adhered to the p-clip. Fasten the p-clip using screws provided. **Do not twist the cord.**

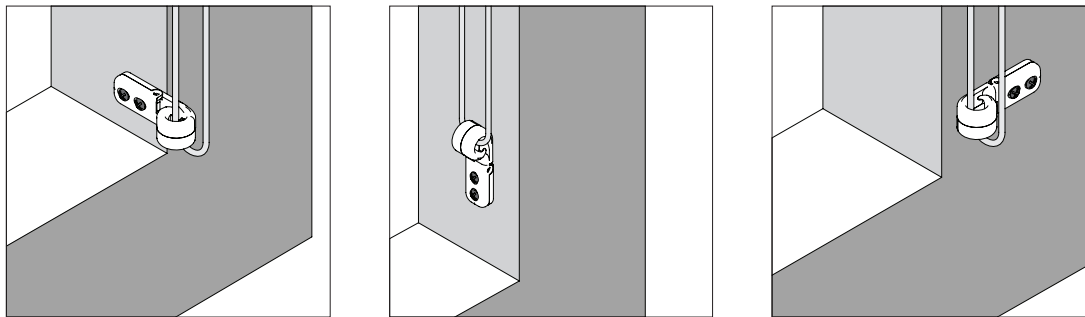

STOPPER INSTALLATION

Pull gradually and gently on the chain to raise and lower the shade. Place the ball stoppers (included) on the chain to prevent the shade from over-rolling at the top and from travelling below the window sill.

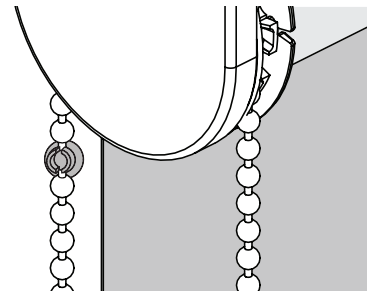

MANUAL OPERATING INSTRUCTIONS

Pull gradually and gently on the chain to raise and lower the shade with fluid motion and always in a downward direction. Jerking, tugging or pulling the chain at a sharp angle may cause damage to the product. Manipulating, folding, or pulling the shade fabric may cause damage to the product. In general, users should refrain from unnecessary handling of the shade fabric and only use the chain controls to operate the shade.

MAINTENANCE & CARE

Fabrics can be periodically dusted using a soft cloth, feather duster, or vacuum cleaner with brush attachment. If staining does occur, most fabrics can be cleaned using a soft cloth with water or a mild soap detergent. Any detergent or cleaning product should be tested on a small area prior to cleaning the fabric. Do NOT use abrasives or harsh cleansers as they can damage the fabric. Dab with a cloth or towel to prevent water spots and roll shade down to the window sill to allow the fabric to air-dry.

Remote User & Programming Guide

Your shades have been custom programmed by our factory to automatically stop at the top and bottom of your windows. Please consult this guide for proper shade operation and programming.

5 Channel Handheld Remote

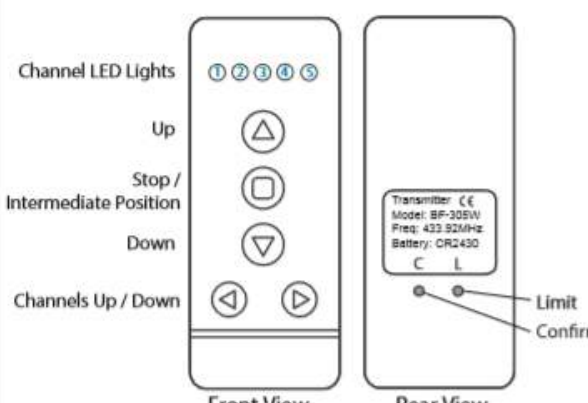



Operating Instructions



Raise Shade: Press and hold  button for 1-2 seconds.

Lower Shade: Press and hold  button for 1-2 seconds.

Stop Shade: Press  button while shade is in motion.

Intermediate Position: Press  button when shade is stopped (must be set by user, see pg. 2 for setup).

Tilt Shade (Zebra & Sheer Horizontal Shades only): Press and release  or  button.

Change Channels: Press  or  arrows to change channels. The numbered LED lights at the top of the remote indicate the current channel. When all LED lights are on, the remote will operate all shades.

5 Channel Wall Remote

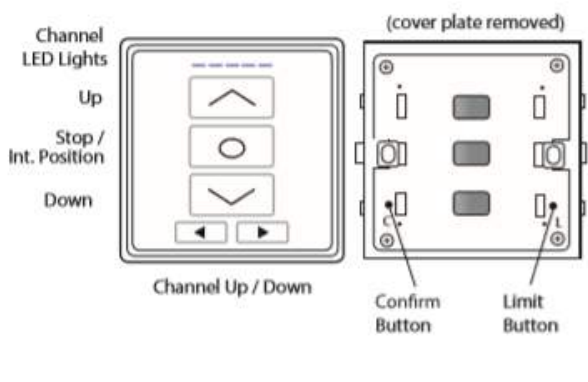



Operating Instructions



Raise Shade: Press and hold  button for 1-2 seconds.

Lower Shade: Press and hold  button for 1-2 seconds.

Stop Shade: Press  button while shade is in motion.

Intermediate Position: Press  button when shade is stopped (must be set by user, see pg. 2 for setup).

Tilt Shade (Zebra & Sheer Horizontal Shades only): Tap or  button.

Change Channels: Press  or  arrows to change channels. The numbered LED lights at the top of the remote indicate the current channel. When all LED lights are on, the remote will operate all shades.

Pairing a New Motor to Your Handheld Remote or Wall Remote

- 1) **Press and hold** the red button on motor for 1-2 seconds until the shade jogs.
- 2) Select the desired channel to which you want to program the motor.
- 3) Using a pen or paperclip, gently press the confirm button marked "C" on the remote. The shade will jog to confirm successful programming.

Operating Shades as Group: By default, when all LED lights on your remote are on, it will control ALL shades within range. If you wish to create your own group on another channel, simply repeat steps 1-3 for additional motors but pair the motors to the same channel.

Removing a Motor From Your Handheld Remote or Wall Remote

(Don't worry, this will not erase the motor's limit positions)

- 1) **Press and hold** the red button on the motor for 4-5 seconds (motor will cycle through two distinct sets of jogs). The motor has now been removed from all paired channels on all remotes.

ATTENTION: Before attempting any of the programming functions in this section, **you must ensure the motor is NOT grouped on the same channel with any other motor(s).**

Follow these steps to isolate a grouped motor for individual programming:

- a) Disconnect the power from other motor(s) by either unplugging the battery wand(s) or DC transformer(s) **OR**
- b) Temporarily removing all other shades from the group channel (see section above for removing a motor).

Reverse Motor Rotation Direction

- 1) Press and hold the "Limit" and "Stop" buttons simultaneously until the motor jogs.

Setting New Upper and Lower Limits

- 1) Select the channel of the shade you want to adjust.
- 2) Press and **hold** the Limit button marked "L" on your remote for 5-6 seconds until the motor jogs.
- 3) Press "down" button to send shade down. **WARNING: ⚠ MOTOR WILL NOT STOP ON ITS OWN!**
- 4) Press "stop" button once the shade reaches desired position at the window sill. Once stopped, the shade can be finely adjusted in small increments by pressing "up" or "down" buttons.
- 5) When satisfied, use a pen or paperclip to press "Confirm" to set the lower limit stop position. **CONTINUE TO STEP 6.**
- 6) Press "up" button to send shade up. **WARNING: ⚠ MOTOR WILL NOT STOP ON ITS OWN!**
- 7) Press "stop" button when shade is **2" - 3" from top to prevent damage to the shade.** Once stopped, shade can be finely adjusted in small increments by pressing "up" or "down" buttons.
- 8) When satisfied, use a pen or paperclip to press "Confirm" to set the new upper limit stop position.

Setting A "Favourite" Intermediate Stop Position

- 1) Bring shade to desired intermediate stop position (i.e 50% height, window transom, latch etc).
- 2) Press and hold the "Limit" and "Up" buttons simultaneously until the motor jogs.