

REQUIRED TOOLS FOR INSTALLATION

OPEN ROLL, MODELS Z-125 | Z-150 | Z-175

Tape Measure

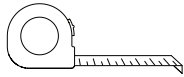

Level



Power Drill / Screwdriver

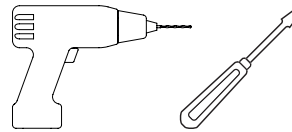

Pencil

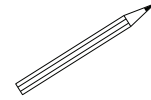

COMES WITH YOUR KIT

Valance

If Ordered

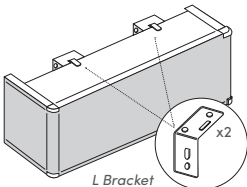

*Note: Returns are optional

Shade Brackets

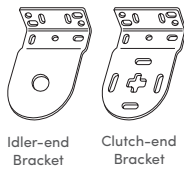

Screws



Roller Shade

Motor | WandControl™ | SpringDrive™

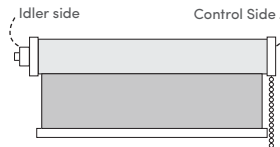

End Caps

If Ordered

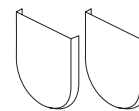

Ball Stoppers

For Chains Only



ROLLER SHADE INSTRUCTIONS

STEP 1 - VALANCE INSTALLATION (If Ordered)

NOTES

- Valance must be installed as a first step before the Roller Shade. If you didn't order a Valance proceed to Step 2.

A - For **INSIDE** mount divide valance width into thirds mark 2 screw holes on the underside of the valance. Drill through cover to secure the valance in place.

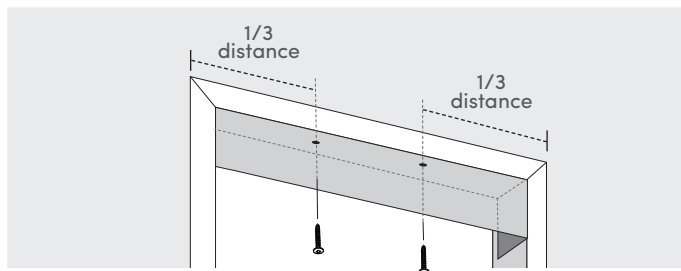

B - For **OUTSIDE** Valance, **mark the location** of the shade mounting brackets with a pencil (see step 2), and measure 1/2" from the top of the bracket to note the location of the Valance L bracket. L brackets should be installed 5"-8" from each end of the valance. Additional bracket(s) may be necessary and should be evenly spaced between the two ends brackets if required.

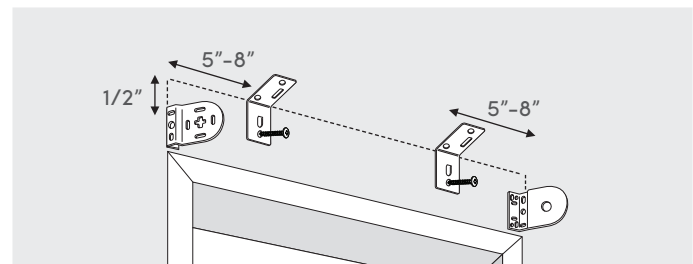

STEP 2 - ROLLER SHADE INSTALLATION

NOTES

- Before fully installing your brackets, note the difference between the clutch and idler brackets.
- In order to ensure the shade does not fall out of the brackets, it is critical that the idler pin is **securely compressed by at least 1/4"** upon installation. If pin is too loose, shade may fall out of brackets. If pin is compressed too tightly, shade may not operate properly.
- End caps are not required when installing a valance.

Idler pin must compress at least 1/4" to ensure shade is properly secured in the brackets.

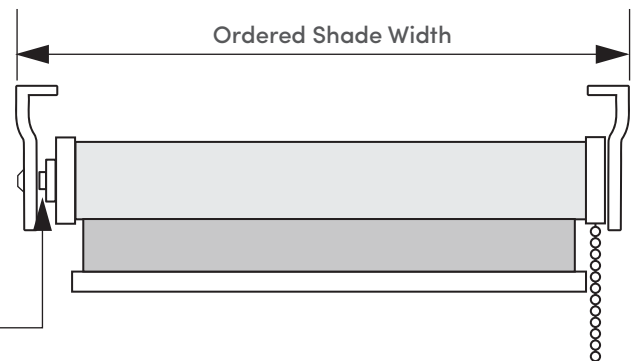

BRACKET INSTALLATION

Mounting Brackets consist of an idler end and a clutch end bracket. Brackets can be positioned for inside mount or outside mount installations. Install the brackets according to L or R side controls.

A Outside Position

B Inside Position

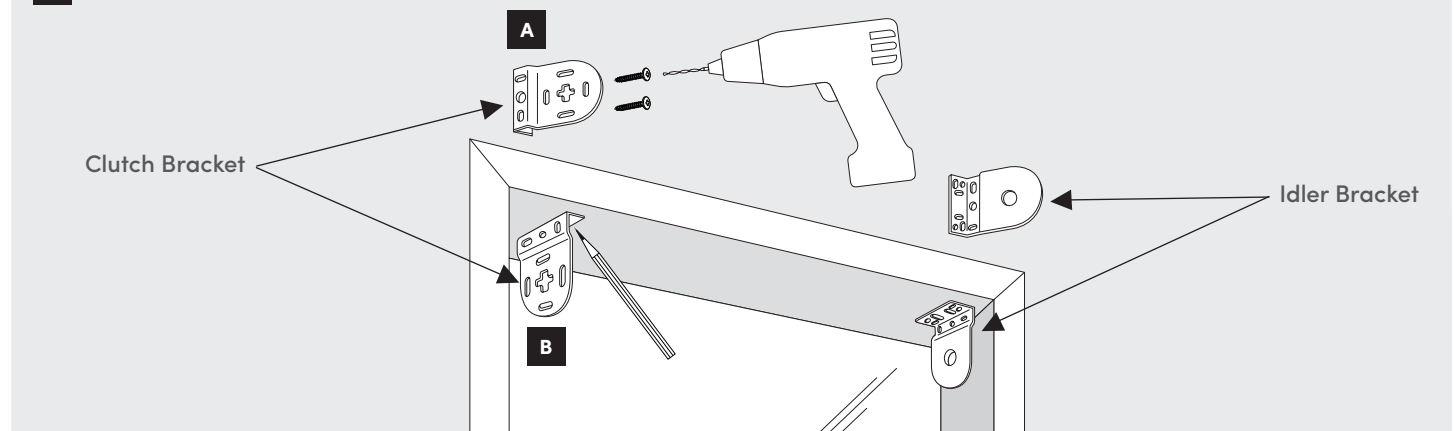

Inside / Outside Mount: Using a steel measuring tape, measure the distance from the outside edge of each bracket according to the ordered shade width. Mark the screw location on the mounting surface with a pencil, snap end caps onto brackets (if ordered).

Fasten brackets according to Left or Right side controls in the marked locations using the screws provided. Ensure brackets are secure, leveled, parallel and facing towards each other.

STEP 3 - SHADE INSTALLATION / HANGING THE SHADE

- NOTES**
- Ensure fabric rolls in the direction you specified (regular or reverse roll)
 - Your control side depends on what you specified

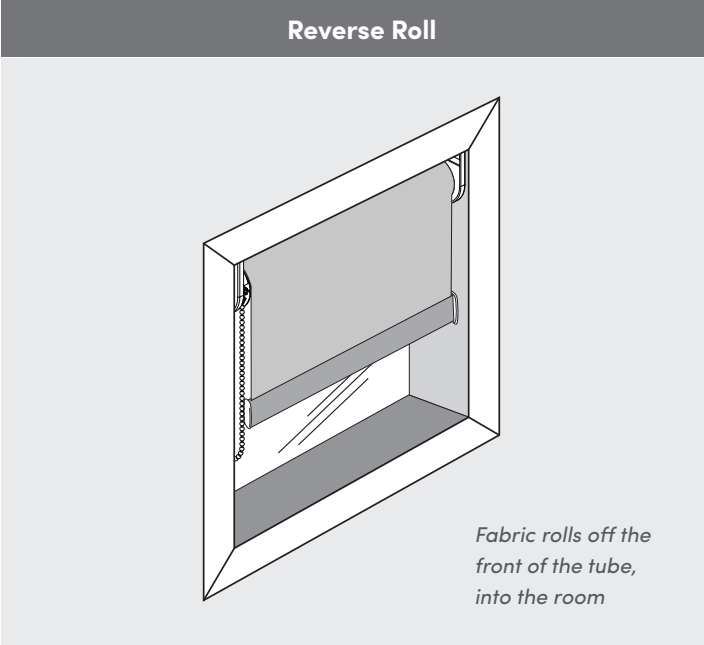
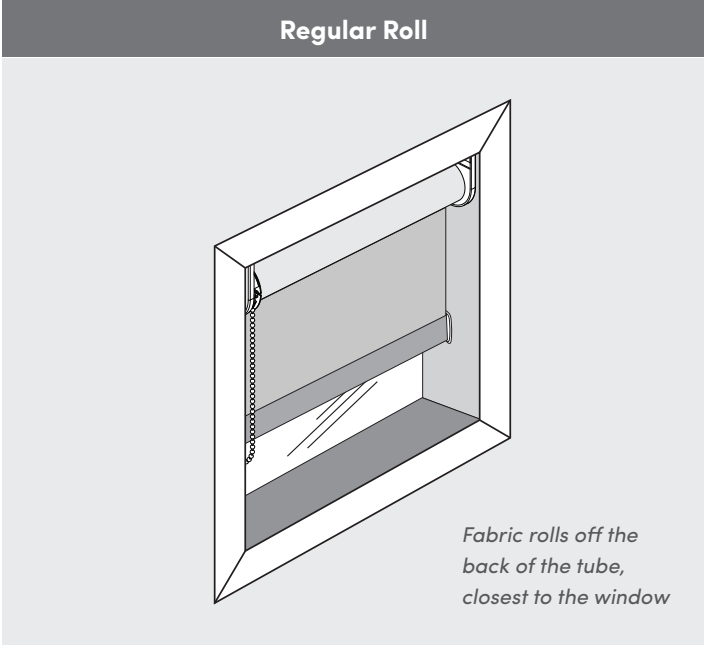

- NOTES**
- Proper installation requires the idler pin to be permanently compressed by at least 1/4" once mounted in the brackets.
 - If necessary, the brackets may need to be installed closer together for a secure fit and to prevent shade from falling out of the brackets.

A - The idler end has spring-loaded pin that allows it to compress in /out. Insert the idler-end into the idler-end bracket, compress and hook the clutch side into the "+" shape of the clutch bracket.

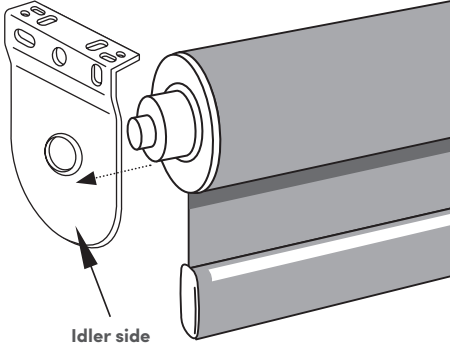

B - Ensure hook on the clutch side is pointing downward and securely fastens into the "+" shaped opening of the clutch bracket.

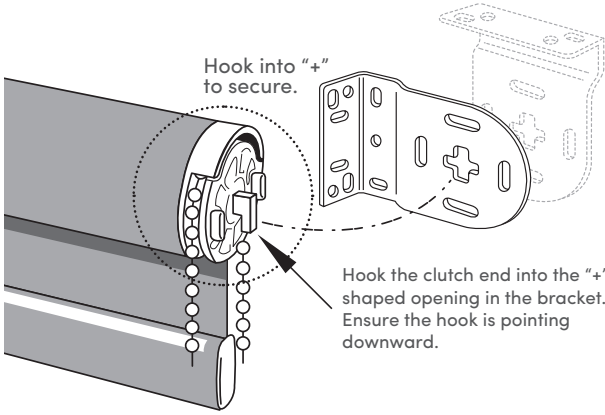

STEP 4 - APPLIES TO CHAIN OPERATION ONLY

CHILD/SAFETY CHAIN TENSIONER INSTALLATION

This device **MUST** be properly installed in accordance with Health Canada regulations on corded window covering products. Fasten cord p-clip against the window frame or wall. Position the p-clip so it does not interfere with the travel of the shade. Cord should be tight, but not under stress when adhered to the p-clip. Fasten the p-clip using screws provided. **Do not twist the cord.**

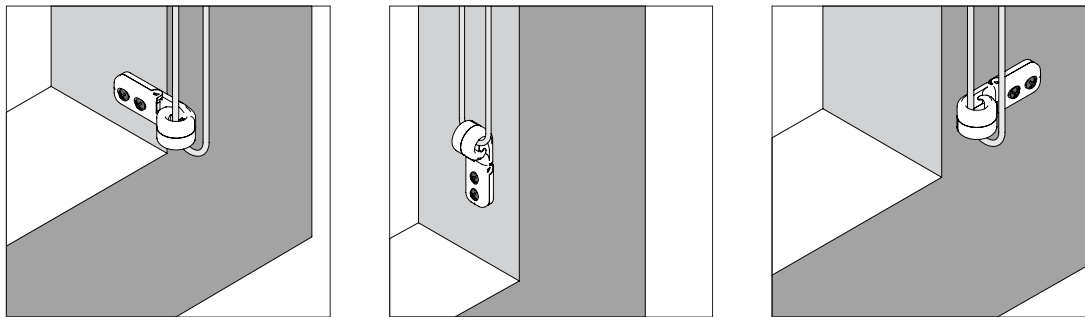

STOPPER INSTALLATION

Pull gradually and gently on the chain to raise and lower the shade. Place the ball stoppers (included) on the chain to prevent the shade from over-rolling at the top and from travelling below the window sill.

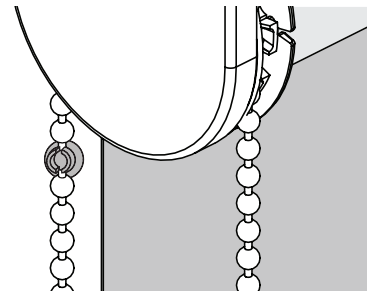

MANUAL OPERATING INSTRUCTIONS

Pull gradually and gently on the chain to raise and lower the shade with fluid motion and always in a downward direction. Jerking, tugging or pulling the chain at a sharp angle may cause damage to the product. Manipulating, folding, or pulling the shade fabric may cause damage to the product. In general, users should refrain from unnecessary handling of the shade fabric and only use the chain controls to operate the shade.

MAINTENANCE & CARE

Fabrics can be periodically dusted using a soft cloth, feather duster, or vacuum cleaner with brush attachment. If staining does occur, most fabrics can be cleaned using a soft cloth with water or a mild soap detergent. Any detergent or cleaning product should be tested on a small area prior to cleaning the fabric. Do NOT use abrasives or harsh cleansers as they can damage the fabric. Dab with a cloth or towel to prevent water spots and roll shade down to the window sill to allow the fabric to air-dry.

SPRINGDRIVE™ HANDLE INSTALLATION

Remove the handle from its packaging. Secure the bottom rail with one hand to prevent the shade from moving.

1



Slowly and carefully, slide the handle onto the bottom rail.

2



When centered, the handle is fully operational.

SPRINGDRIVE™ HANDLE OPTIONS

Clear handle
with tassel

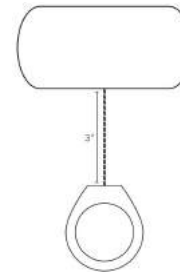

Clear handle

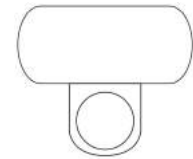

Remote User & Programming Guide

Your shades have been custom programmed by our factory to automatically stop at the top and bottom of your windows. Please consult this guide for proper shade operation and programming.

5 Channel Handheld Remote

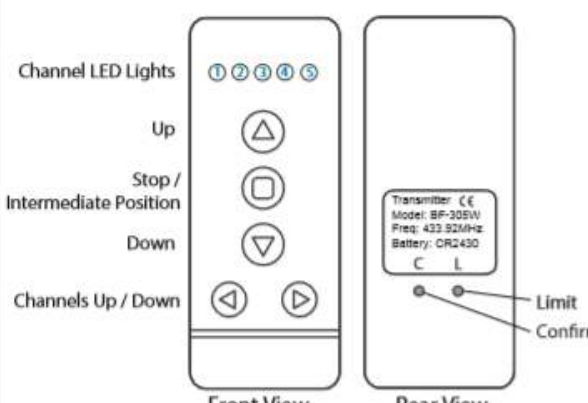



Operating Instructions



Raise Shade: Press and hold  button for 1-2 seconds.

Lower Shade: Press and hold  button for 1-2 seconds.

Stop Shade: Press  button while shade is in motion.

Intermediate Position: Press  button when shade is stopped (must be set by user, see pg. 2 for setup).

Tilt Shade (Zebra & Sheer Horizontal Shades only): Press and release  or  button.

Change Channels: Press  or  arrows to change channels. The numbered LED lights at the top of the remote indicate the current channel. When all LED lights are on, the remote will operate all shades.

5 Channel Wall Remote

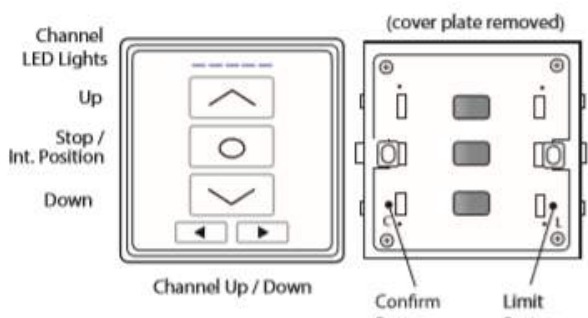



Operating Instructions



Raise Shade: Press and hold  button for 1-2 seconds.

Lower Shade: Press and hold  button for 1-2 seconds.

Stop Shade: Press  button while shade is in motion.

Intermediate Position: Press  button when shade is stopped (must be set by user, see pg. 2 for setup).

Tilt Shade (Zebra & Sheer Horizontal Shades only): Tap or  button.

Change Channels: Press  or  arrows to change channels. The numbered LED lights at the top of the remote indicate the current channel. When all LED lights are on, the remote will operate all shades.

Pairing a New Motor to Your Handheld Remote or Wall Remote

- 1) **Press and hold** the red button on motor for 1-2 seconds until the shade jogs.
- 2) Select the desired channel to which you want to program the motor.
- 3) Using a pen or paperclip, gently press the confirm button marked "C" on the remote. The shade will jog to confirm successful programming.

Operating Shades as Group: By default, when all LED lights on your remote are on, it will control ALL shades within range. If you wish to create your own group on another channel, simply repeat steps 1-3 for additional motors but pair the motors to the same channel.

Removing a Motor From Your Handheld Remote or Wall Remote

(Don't worry, this will not erase the motor's limit positions)

- 1) **Press and hold** the red button on the motor for 4-5 seconds (motor will cycle through two distinct sets of jogs). The motor has now been removed from all paired channels on all remotes.

ATTENTION: Before attempting any of the programming functions in this section, **you must ensure the motor is NOT grouped on the same channel with any other motor(s).**

Follow these steps to isolate a grouped motor for individual programming:

- a) Disconnect the power from other motor(s) by either unplugging the battery wand(s) or DC transformer(s) **OR**
- b) Temporarily removing all other shades from the group channel (see section above for removing a motor).

Reverse Motor Rotation Direction

- 1) Press and hold the "Limit" and "Stop" buttons simultaneously until the motor jogs.

Setting New Upper and Lower Limits

- 1) Select the channel of the shade you want to adjust.
- 2) Press and **hold** the Limit button marked "L" on your remote for 5-6 seconds until the motor jogs.
- 3) Press "down" button to send shade down. **WARNING: ⚠️ MOTOR WILL NOT STOP ON ITS OWN!**
- 4) Press "stop" button once the shade reaches desired position at the window sill. Once stopped, the shade can be finely adjusted in small increments by pressing "up" or "down" buttons.
- 5) When satisfied, use a pen or paperclip to press "Confirm" to set the lower limit stop position. **CONTINUE TO STEP 6.**
- 6) Press "up" button to send shade up. **WARNING: ⚠️ MOTOR WILL NOT STOP ON ITS OWN!**
- 7) Press "stop" button when shade is **2" - 3" from top to prevent damage to the shade.** Once stopped, shade can be finely adjusted in small increments by pressing "up" or "down" buttons.
- 8) When satisfied, use a pen or paperclip to press "Confirm" to set the new upper limit stop position.

Setting A "Favourite" Intermediate Stop Position

- 1) Bring shade to desired intermediate stop position (i.e 50% height, window transom, latch etc).
- 2) Press and hold the "Limit" and "Up" buttons simultaneously until the motor jogs.

SETUP CODE CODE DE CONFIGURATION

N2421

Getting to know your Smart Controller

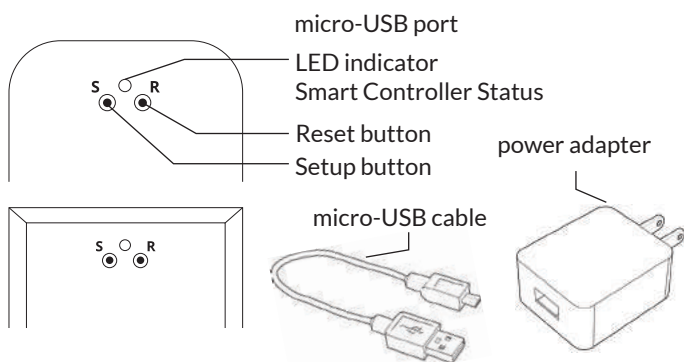

Smart Controller Status:
Flashing blue - Hotspot available
Flashing green - Connecting to the WiFi network
Pulsing cyan/blue-green - Connected to the Internet

Getting Started

- 1 Download the Neo Smart Blinds app**

Download the app to your phone or tablet by searching **Neo Smart Blinds** on Google Play or the App Store.
Note: Do not install Neo Smart Blinds Blue
- 2 Plug in your Smart Controller in reach of your home WiFi**

Choose a place not too far from your home router or a place you know has good WiFi signal strength. You will be able to change its location after, if necessary.
- 3 Create an account and choose the setup code written on the cover**

After opening the app, tap on Create one to create a new account. Enter a valid email address and choose a password, select the region time zone from the place where the Smart Controller will be located. Choose the setup code written in the cover and tap on Register.
- 4 Follow the app step by step to add the Smart Controller**

Have in hand the home WiFi password. It will be necessary to connect the Smart Controller to the Internet.
Note: Some Android users won't be connected quickly to the hotspot. If it is the case, please wait about 10 seconds before returning to the app. During this time, your device may notify you that the hotspot does not have Internet access, and will prompt you whether you want to remain connected. You need to select the option that will allow you to keep connected before returning to the app.

System requirements

- A strong WiFi signal (3 bars or more) in the location where you will setup your Smart Controller.
- The Smart Controller only supports 2.4GHz WiFi (IEEE 802.11b/g/n), not 5GHz. WiFi security needs to be set to WPA-PSK or WPA2-PSK.
- A smartphone or tablet running Android 5.0 (Lollipop) or higher, or iOS 8 or higher is needed.

Troubleshooting

The home WiFi doesn't appear in the step 4

Try rescanning, if the problem persists, you will need to reposition the Smart Controller to a place with stronger WiFi signal. In this case, exit the process (tap on the menu, then tap Your Rooms), replace the Smart Controller and start over.

The Smart Controller LED in the bottom is not blinking blue

The process fails in the last step

Press the S button for 10 seconds, then press the R button once and start over. Pay special attention when typing the WiFi password.

Need more help?

Visit neosmartblinds.com/smartcontroller for detailed instructions about how to use the app and troubleshooting.

Integrations

Smart home devices

Visit neosmartblinds.com/smartcontroller-integrations for detailed information about connecting to Amazon Alexa, Google Home and other systems.

Control4

Please send an email to tech@neosmartblinds.com with your name, your email and your company's name. This information is necessary to always send to you any further driver update.

Legal Information

FCC

This equipment has been tested and found to comply with the limits for a Class B digital device, pursuant to Part 15 of the FCC Rules. These limits are designed to provide reasonable protection against harmful interference in a residential installation. This equipment generates uses and can radiate radio frequency energy and, if not installed and used in accordance with the instructions, may cause harmful interference to radio communications. However, there is no guarantee that interference will not occur in a particular installation. If this equipment does cause harmful interference to radio or television reception, which can be determined by turning the equipment off and on, the user is encouraged to try to correct the interference by one of the following measures:

- Reorient or relocate the receiving antenna.
- Increase the separation between the equipment and receiver.
- Connect the equipment into an outlet on a circuit different from that to which the receiver is connected.
- Consult the dealer or an experienced radio/TV technician for help

Contains transmitter module FCC ID: COFWNMNB11

To comply with FCC/IC RF exposure limits for general population/ uncontrolled exposure, the antenna(s) used for this transmitter must be installed to provide a separation distance of at least 20 cm from all persons and must not be co-located or operating in conjunction with any other antenna or transmitter.

IC

This device complies with Industry Canada's licence-exempt RSSs. Operation is subject to the following two conditions:

- This device may not cause interference; and
- This device must accept any interference, including interference that may cause undesired operation of the device.

This device meets the exemption from the routine evaluation limits in section 2.5 of RSS102 and users can obtain Canadian information on RF exposure and compliance.

Contains transmitter module IC: 10293A-WMNB11

This End equipment should be installed and operated with a minimum distance of 20 centimeters between the radiator and your body.

