

INSTALLATION INSTRUCTIONS

Aluminum Blinds

- Standard -
- Lift & Lock -

- 1" Deluxe**
- 1" Traditional**
- 1" Value & 1" Basic**
- 2" Macro**



Thank you for your purchase. This blind has been custom built for you from the highest quality materials. To avoid errors and save valuable time, please read these instructions before installing your new blind.

TOOLS YOU WILL NEED

1. Pencil or Marker
2. Measuring Tape
3. Flat-Head Screwdriver
4. Phillips Screwdriver
5. Carpenter's Level
6. Power Drill
7. Mounting Fasteners





Mounting Surface	Fastener
Drywall, Plaster	Wall Anchors, Expansion Bolts (Not Provided) 
Metal	Sheet Metal Screws (Not Provided) 
Wood	No. 8 Hex Head Screws (Provided) 

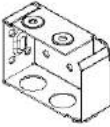

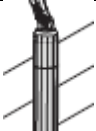









TABLE OF CONTENTS

Getting Started: Parts	Page 3
Mounting with Box Brackets	Page 4
Mounting with Hidden Brackets	Page 5
Assemble the Wand	Page 6
Installing the Valance	Page 6
How to Operate	Page 7
Troubleshooting	Page 8
Cleaning Instructions	Page 9
Child Safety.....	Page 10
Warranty Information	Page 11

GETTING STARTED

All of the required installation components are wrapped in your package along with these instructions. Parts vary depending on which Aluminum blind was ordered.

Parts you have correspond to the standard parts shown below. *NOTE: Some parts may vary depending upon your chosen mounting options, whether intermediate brackets are required or your chosen control system options.*

Standard Parts	1" Deluxe	1" Traditional	1" Value or 1" Basic	2" Macro
Installation Bracket (Pair)				
Wand (Length varies by blind height)				
Valance Clips (Pair)	N/A			
Installation Screws (varies by bracket)				
Child Safety Kit	Standard	Standard	Standard	Standard

Optional Parts:

- **Center Support Bracket** (quantity varies by blind width)
- **Extension Brackets**
- **Spacer Blocks**
- **Hold Down Brackets**

Mounting with Box Brackets

1" Value & 1" Basic, 1" Traditional, 2" Macro

Right-hand and left-hand Box mounting brackets are packed with each blind. The brackets are stamped R or RH and L or LH on the inside of each bracket for easy identification. These brackets are used for all types of mounting--outside, inside and ceiling mounts. Bracket doors must face inside of room.

INSIDE MOUNT: With mounting brackets level and flush with the window frame, screw through holes on the inside of bracket into window frame.

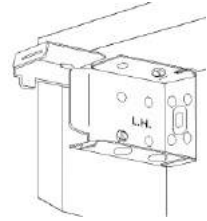

OUTSIDE/CEILING MOUNT: With blind open, hold up to wall/ceiling in the position you want it to hang. Make sure the blind is centered and level. Mark wall 1/4" past each end of headrail. Remove blind and place mounting brackets level on pencil marks. Secure with screws.

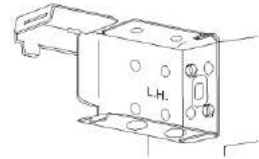

END STIFFENERS: These are located at the ends of the headrail to keep the headrail rigid and provide end adjustments. If headrail moves left or right more than 1/8 inch, adjust tabs outward on end stiffeners.



INSERT HEADRAIL: Open bracket door latches by pushing up on bottom of bracket while swinging the bracket door to the open position. Slide headrail into mounting brackets. Close bracket door latches.

EXTENSION BRACKETS: Used to mount the blind farther away from the wall/window to clear thick window moldings or ledges. Secure extension bracket to wall with two LONG screws. Using nuts and two SHORT bolts, attach mounting bracket to extension bracket or, attach center support bracket to extension bracket like a ceiling mount.

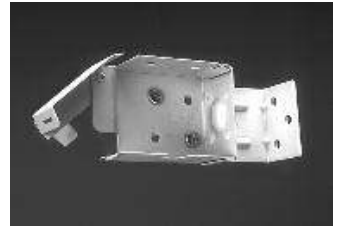

Mounting with Hidden Brackets

1" Deluxe

Positioning of Brackets: Brackets should be mounted no more than 60 inches apart. Brackets mounted toward the end of the blind should be positioned not less than 1/4" from ends of the blind (This is to allow room for the end cap when the blind is mounted).

NOTE: DO NOT position brackets directly over the top of string ladders.

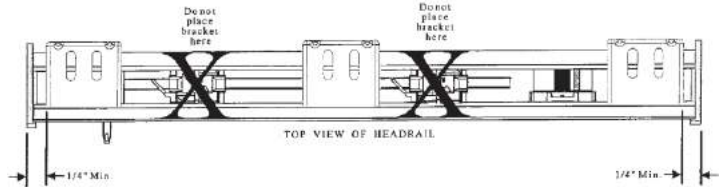

Tab slopes downward giving a lead-in for the insertion of the headrail from the front.

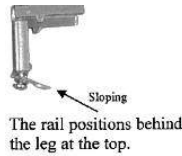

INSERT HEADRAIL: The rail positions behind the leg at the top. Make sure the rear lip of the headrail is caught behind the rear leg of the bracket.



SECURING THE BLIND: Tighten the screw in the bottom of bracket to secure the blinds.

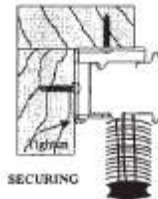

NOTE: If more than two brackets are required, insert the headrail in the center brackets first. If necessary, tighten the screws on the center bracket to hold the headrail in position allowing insertion into the other brackets. Tighten screws in bottom of bracket.

EXTENSION BRACKETS: Follow instructions for bracket location. Use appropriate fasteners to bolt the mounting brackets to the extension. It is suggested to use two fasteners diagonally, to the side of the extension. The extension should also be mounted to the window frame or wall using two diagonally located screws.

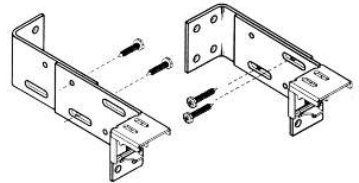

Assembling the Wand

All Styles

The wand provided has a metal hook with a plastic sleeve over the hook. Remove the plastic sleeve by pulling upward. The hook still attached to the wand will be in the open position.

Next, slide the plastic sleeve you removed over the metal shaft protruding from the headrail. Holding the sleeve above the tilter shaft hole, insert the wand hook through the shaft hole until it rests in the bend of the hook. Then slide the plastic sleeve back down to cover the hook until it is back in the closed position. Now turn the wand to tilt the slats open and closed.

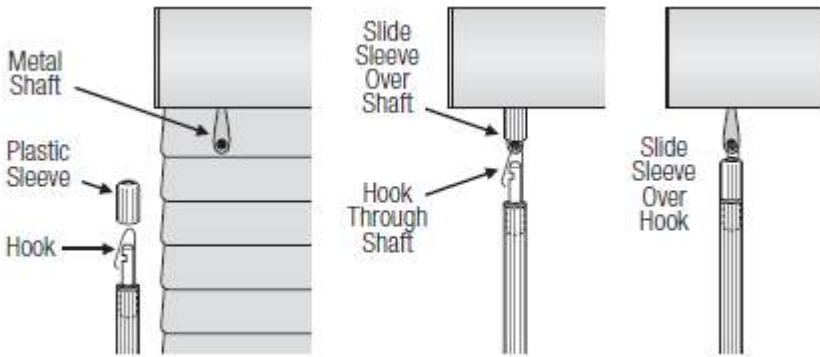

Installing the Valance

1" Value & 1" Basic, 1" Traditional, 2" Macro

2 Slat Valance with Valance Clips (1" Value & 1" Basic):

Attach valance clips 2" from each end of the headrail. Space additional clip(s) evenly between the two end clips so that the valance clips are no more than 36" apart.

NOTE: Do not place the valance clips where they could interfere with any working parts.

Channel Valance (1" Traditional & 2" Macro)

The slats for the valance will come pre-inserted in the channel valance. Attach the clips to the headrail. Attach the channel valance to the clips.

NOTE: If the valance was ordered with returns, bend the channel valance at the score on the back of the channel valance prior to attaching to the clips.

How to Operate

TO TILT SLATS: Rotate wand or pull the tilt cord (2" Macro Only) to desired slat angle.

NOTE: Prior to raising or lowering, the slats should be tilted to the open position.



Standard Operation

TO RAISE BLIND: Pull cord towards the middle and down until blind reaches desired height. Return the cord to vertical position to re-engage the locking mechanism.



TO LOWER BLIND: Gently pull cord toward center of blind until lock releases. Let cord slip slowly through fingers until blind reaches desired height. Move cord toward outside of blind and release. Blind will lock automatically.



Lift & Lock

TO RAISE BLIND: Grasp the bottom rail near the center with one hand while balancing the bottom rail with your other hand. Fully press the center button with your thumb and gently lift the bottom rail. Allow the slats to stack evenly by gradually lifting the bottom rail while the center button is fully depressed. Hold the rail still at the desired position while releasing the button.

NOTE: When raising Inside Mount blinds, pull the bottom rail slightly toward you. Press the center button and gently raise the bottom rail. Once the desired height is reached, hold the rail in place while releasing the button. Place the blind back into the window opening and the blind will stay in that position.

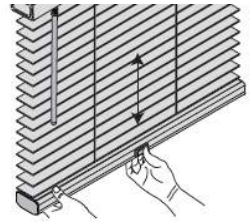

TO LOWER BLIND: Prior to lowering the blind, fully press the center button with your thumb and pull the bottom rail down to the desired height while the button is fully depressed. Once the blind reaches the preferred position, hold it there while releasing the button and the blind will stay in that position.

NOTE: When lowering Inside Mount blinds to the full-down position, pull the bottom rail down and slightly toward you, approximately 1" beyond the sill. Release the button, then lift and place the bottom rail up onto the sill.

Troubleshooting

ALIGNING BLIND: For all blinds the ladders may become misaligned in transit. After installation tilt the blind opened and closed several times to allow the ladders and slats to align themselves.

BOTTOMRAIL IS NOT LEVEL

Lift & Lock blinds feature a skew adjust mechanism located on the bottom of the headrail

On 1" Lift & Lock Blinds there are pockets and ferrules that can be used to adjust the bottomrail. Adjust the ferrule on the same side of the bottomrail that you want to raise or lower.



- Locate the ferrule, seated in a pocket in the headrail.
- Remove the ferrule by pulling on the excess cord. If the cord has been trimmed, you will need to use needlenose pliers to access it.
- **To shorten the cord**, hold the cord tight under the ferrule. Then slide the ferrule up toward the pocket.
- **To lengthen the cord**, hold the cord tight between the pocket and the ferrule. Then slide the ferrule down.
- After adjusting, place the ferrule fully back into the pocket.

2" Lift & Lock Blinds feature a skew adjuster also located in the bottom of the headrail.

- To level the blind, raise the low side of the bottom rail by turning the screw adjustment feature on the headrail clockwise with a coin or screwdriver while lifting the weight from the bottom rail.

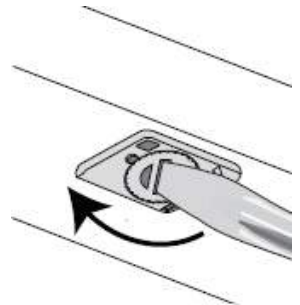

NOTE: Turn the skew adjustment that is on the same side as the low side of the bottom rail.

On 2" Lift & Lock Blinds, if the blind height is too long, turn all the skew adjustment features clockwise to raise the entire bottom rail to the desired height while lifting the weight from the bottom rail. There is an adjustment range of approximately 1-1/4".

Cleaning Instructions

DUSTING: Like any piece of furniture, dust your blinds regularly. Use an ordinary soft, clean cloth, chemically treated dust cloth, dusting mitt or cylindrical dust brushes especially designed for blinds. Lower the blind to its full length, tilt the slats almost fully closed and dust. Then dust the reverse side of the slats in the same manner. In order to reach the dust where the slats overlap, it is best not to fully close the blind in either position.

VACUUMING: To use your vacuum for cleaning your blind, use the brush attachment provide with your vacuum. Use the same procedure as mentioned above.

DAMP CLEANING: To wipe your blinds, use a soft cloth or sponge. Use warm or cold water - NOT hot water. Place toweling on the floor or sill and wipe the blind in sections.

IMPORTANT NOTE: Ultrasonic cleaning is NOT recommended for aluminum blinds.



WARNING

For more safety information call 1-888-501-8364
in the U.S. or 1-866-662-0666 in Canada.

Young children can **STRANGLE** in cord loops and in the loop above the cord stop. They can also wrap cords around their necks and **STRANGLE**.

- Always keep cords out of children's reach.
- Move cribs, playpens and other furniture away from cords. Children can climb furniture to get to cords.

Cord Stop

- This component breaks apart with minimal pressure should a child or pet become entangled in the top lift cords.
- It also acts as a stopper to prevent inner cords from being pulled through the blind, which can also create potential entanglement.

Reassembly of Cord Stop

- Reinsert any loose cords into the top notches of the cord stop. There is a notch on each side.
- Line up the two halves of the cord stop and snap the pieces back together.

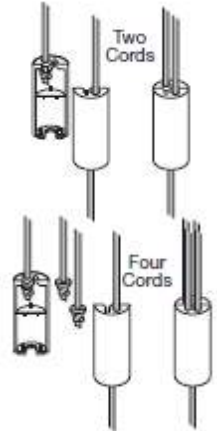

Cord Cleats

We recommend the use of cord cleats.

- Attach two cord cleats 6" to 12" apart at a height where they will be out of the reach of children. Take into account that a child may stand on furniture attempting to reach the cords.
- Be sure the cleats are firmly secured.
- Once the cleats are attached, wrap excess cord around them after each use of the blind.



WARRANTY INFORMATION

Lifetime Limited Warranty covering our Custom Made Blinds

We extend this lifetime limited warranty to the original purchaser. This warranty applies only to manually operated Custom Products properly installed in the window, door or interior area for which they were intended. Installation of the product must be in accordance with accompanying instructions. The product cannot be modified. It is the purchaser's responsibility to maintain and clean the product in compliance with the instruction provided. The product must be used only in the window for which it was purchased. Damage to the product resulting from misuse, abuse, direct exposure to salty air or discoloration due to sunlight or the passage of time is not covered by this warranty.

This warranty does not apply to conditions caused by normal wear and tear upon the product. This warranty is exclusive and in lieu of all other obligations, liabilities or warranties. In no event shall the Manufacturer be liable for incidental or consequential damages or for any other direct or indirect damage, loss, cost, expense or fee. Some states do not allow the exclusion or limitation of incidental or consequential damages, so this exclusion or limitation may not apply to you.

In the event of a defect under this warranty, we will repair or replace the product, at our option, provided it is returned to our store. Our warranty obligation excludes shipping charges and labor costs for measuring and installation. Repairs will be made with like or similar parts. This warranty gives you specific legal rights, and you may have other rights which vary from state to state.

Notes: Motorization Systems are warranted for five years from the date of purchase. Specialty Blinds and Shades are warranted for one year from the date of purchase.

This warranty does not apply to Commercial Orders.