

Drapery Rod

Read all instructions prior to installation.

SelectBlinds™.ca

Tools Required (not included)

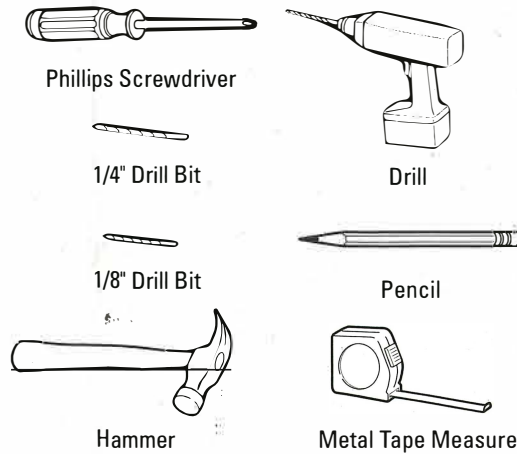

Parts Included

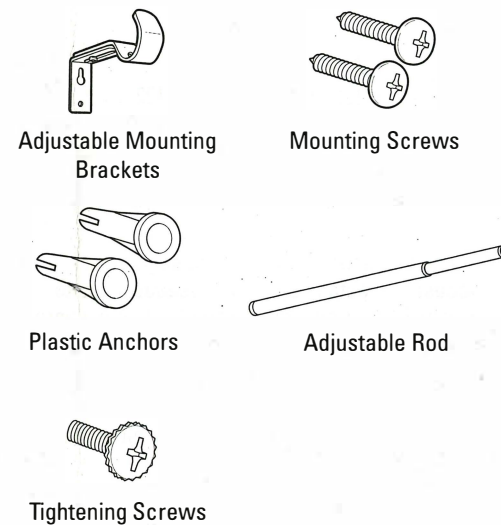

Package Contents	Pole Length		
	36"-66" (91-167 cm)	66"-120" (167-305 cm)	120"-180" (305-457 cm)
Adjustable Brackets	3	4	6
Mounting Screws	6	8	12
Plastic Anchors	6	8	12
Tightening Screws	3	4	6

*End Caps are not included with all rod sets

1 Mark the bracket location

- Place mounting brackets against the wall at the desired locations for the appropriate pole lengths. Brackets should be evenly spaced.
- Mark screw holes with pencil. Be sure pencil marks are leveled across opening.

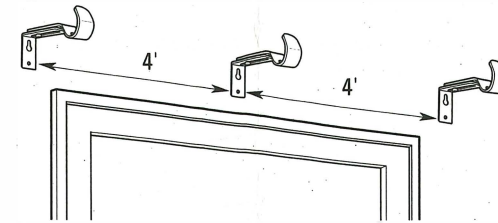

2A For wood trim or wall stud—Drill the pilot holes

- Use 1/8" bit to drill pilot holes.

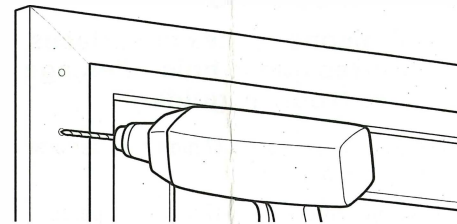

2B For drywall or non-wood surfaces—Drill the pilot holes

- Use 1/4" bit to drill pilot holes.

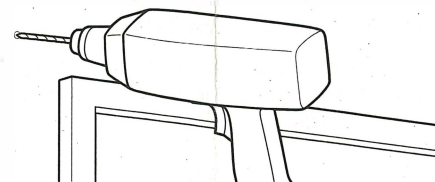

- Push or gently hammer plastic anchors into holes until flush against wall surface.

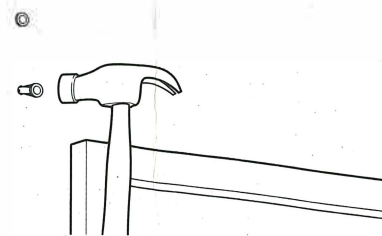

3 Install the adjustable brackets

Mount each adjustable bracket using the provided screws.

- Prior to mounting, loosen projection screw and slide away bracket extension.
- Install screws through brackets. Do not overly tighten screws fastened into plastic anchors.

*Mount all brackets included for added support.

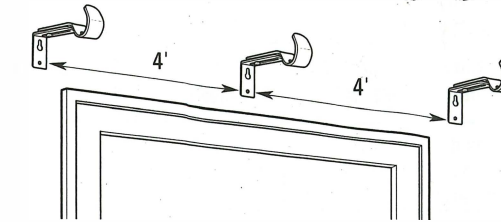

- Adjust bracket extension as needed to desired position and tighten projection screw. Repeat this step for each bracket.

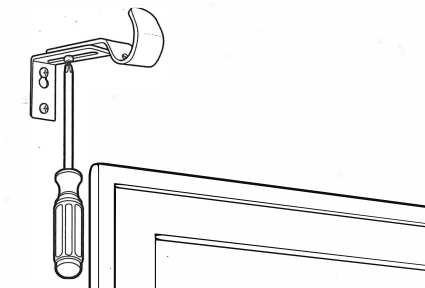

4 Place drapery on rod

- Place drapery treatment onto rod.

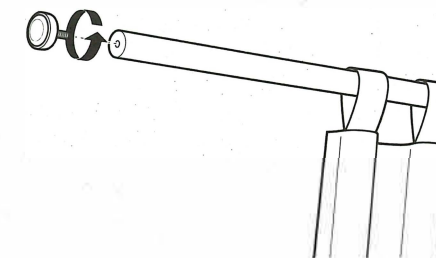

5 Install end caps

- Screw in end caps or 1 3/8" finial sets (sold separately).

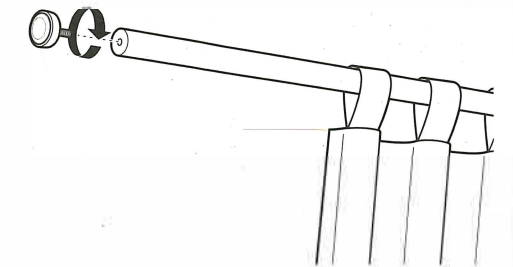

6 Install rod and drapery

- Extend rod to desired length. Place rod with drapery into brackets. Adjust rod and drapery to desired position.

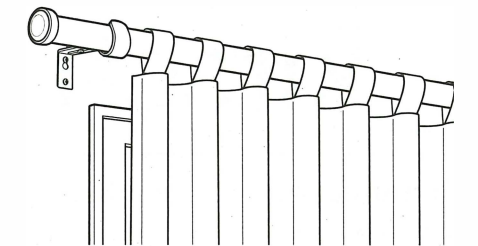

- Lock rod in position by tightening screws into back of bracket.

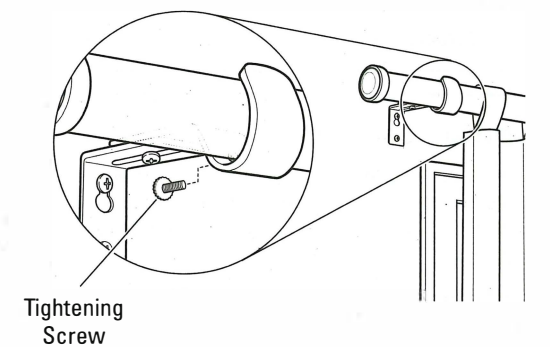

Tightening Screw